

PART No. 1414PHCLP

for more information visit  
[www.hammfg.com](http://www.hammfg.com)

Data subject to change without notice

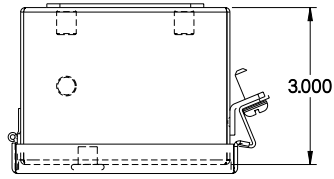

TOP VIEW

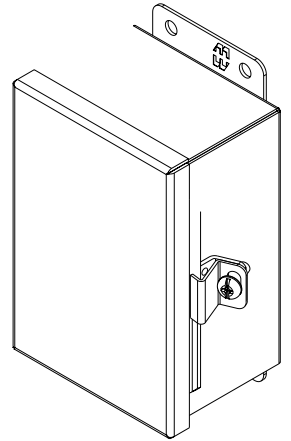

ISOMETRIC VIEW

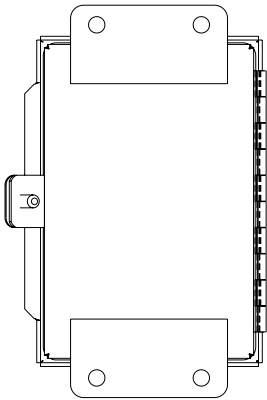

BACK VIEW

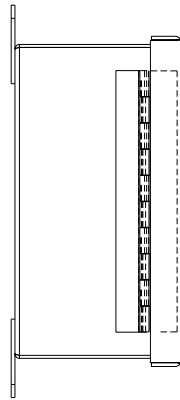

LEFT SIDE VIEW

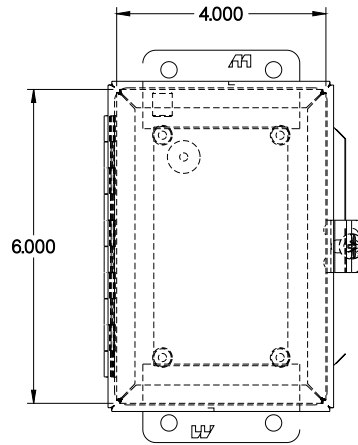

FRONT VIEW

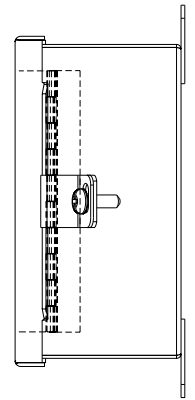

RIGHT SIDE VIEW

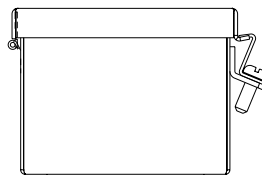

BOTTOM VIEW